

Controller for cooling applications

Order number: 900320.123

As of: 25.09.2023 V1.74

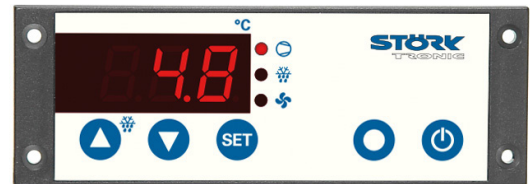

Wiring diagram

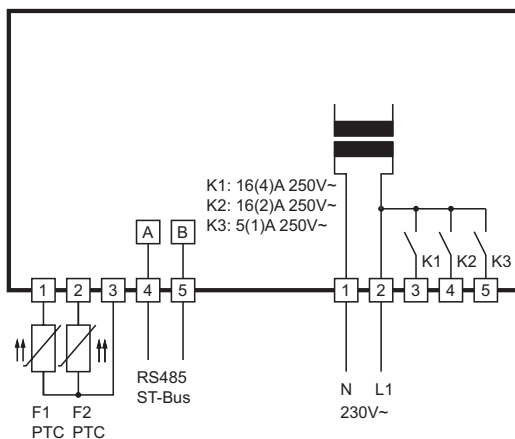

Product description

The cooling controller ST121-KI1KAR.112 with two sensor inputs and five keys is used for the thermostatic temperature control of refrigerating plants. It is supplied with 230V AC and has two three relays. The functions of the outputs and special keys can be freely selected, thus various applications with only one controller are possible. The controller, for example, can operate with two coolers if the evaporator sensor is parametered as sensor for a second refrigerating chamber. Networking of the controller takes place via the ST-Bus interface.

Sensor:	PTC
Range:	-50...150 °C
Front size:	120 mm x 42 mm
Panel cut-out:	102.5 mm x 35 mm
Tightness:	Front IP65
Connection:	screw terminal

Operating levels:

SOFTWARE

COOLING CONTROLLER ST121-xxx.112

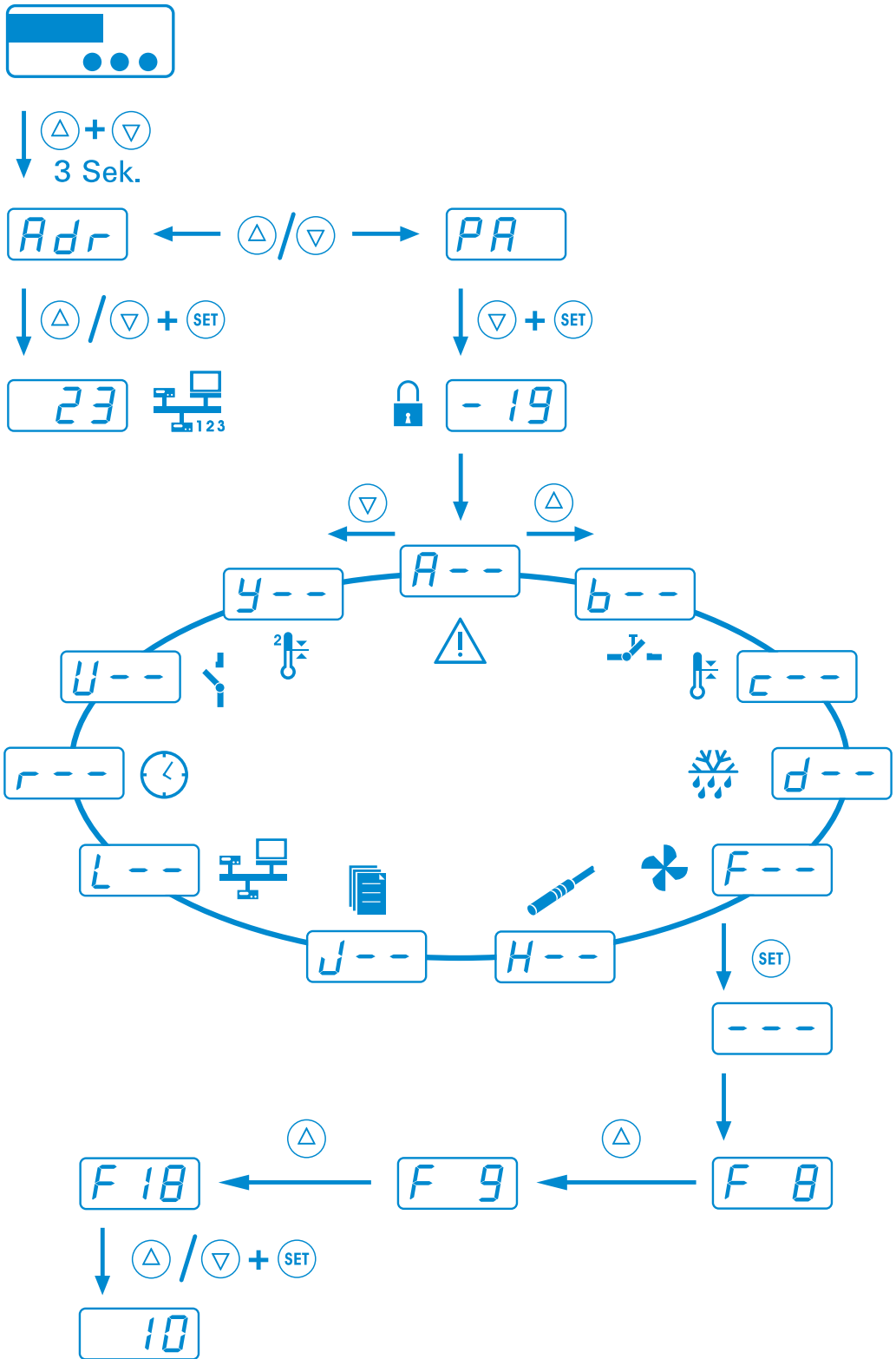

GENERAL NOTES

The ST.....112 controllers are designed for general use in refrigerating plants.

Depending on the existing hardware, up to four temperature sensors can be connected. These can either be used for capturing the cold store temperature, evaporator temperature, super-frost core temperature, the temperature of a second control circuit or the temperature of the condenser. The type, function, offset and weighting of each sensor can be configured separately via parameters. Additionally, an analogue input (4..20mA) can be made available for capturing pressure levels, e.g. for condenser/fan control, provided that the required hardware is available.

The max. four digital inputs can also be configured separately, depending on the hardware installed. Possible functions include: standby, door contact, high-pressure or low-pressure switch.

Depending on the hardware, up to eight relay outputs are possible the functions of which can be configured as required via parameters. Please refer to the specifications of the hardware installed to ensure that the relays are not overloaded. Also refer to the circuit diagram in the corresponding device manual.

All parameters can also be accessed via the RS485 interface. If an internal clock is provided in the hardware, the corresponding functions, e.g. defrosting or night-time increase/decrease of setpoint, can be set and started via parameters.

CONTROL KEYS

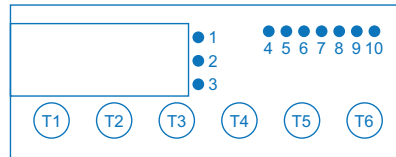

Key T1: UP
 By pressing this key, the parameter or parameter value is increased. A further function of the key can be set with parameter **b1**.

Key T2: DOWN
 By pressing this key, the parameter or parameter value is decreased. A further function of the key can be set with parameter **b2**.

Key T3: SET
 While this key is pressed, the setpoint is indicated. The function of the key can be set with parameter **b3** (unchangeable in this case)..

Key T5: function key
 The function of the key can be set with parameter **b5**.

Key T6: Standby
 The function of the key can be set with parameter **b6**. It is preset as standby key. Thus the unit can be switched on or off (no mains disconnection).

The cooling controller is generally controlled using the buttons UP, DOWN and SET. The standard display indicates the temperature of the cold store (actual temperature value). Press SET button to switch over the display to the required cold store temperature (setpoint temperature).

The setpoint temperature can only be changed by pressing buttons SET and UP or SET and DOWN at the same time. While pressing the buttons, the changing setpoint temperature is displayed. After changing the setpoint temperature and releasing the buttons, the actual temperature is displayed again. This is the standard setting method.

If you press the STANDBY button during operation (for at least 3 seconds), the cooling controller is switched off and the message **RUS** will be displayed. To switch on the controller again, press the STANDBY button again.

In addition to setting the temperature value, the buttons UP and DOWN perform other functions, too. Pressing the UP for 3 seconds will trigger a non-standard defrosting operation of the refrigerating plant. In the case of an alarm (with buzzer triggered), the DOWN button can be used for acknowledging the buzzer sound.

PARAMETERISATION

Parameterisation of the cooling controller is done in the factory or during commissioning of a cold store by qualified staff. Wrong or inappropriate parameterisation can result in malfunction and damage of the refrigerated goods. Parameter setting is possible only after entering one or more passwords. In the following list of parameters, all parameters of a complex cooling controller are listed. Please note, however, that the parameters listed are only available in controller designs where the relevant hardware (outputs, inputs, sensors and internal clock) is available.

Parameterisation is possible at any time. The control operation is not interrupted during parameterisation, but can have a direct influence on it. If no button is pressed for 2 minutes, the operation is stopped and the actual value is displayed again.

To activate parameterisation mode, press buttons UP and DOWN at the same time. After approx. 3 seconds, the code word **Rdr** will be displayed. Press UP or DOWN to switch between code words **PR** and **Rdr**. All other settings / value specifications in parameter setting mode are performed using the default value setting method, i.e. pressing buttons SET and UP / DOWN at the same time

Rdr NETWORK ADDRESS

The code word **Rdr** allows you to set a network address. This is mandatory for the commissioning of networked systems.

PR ENTERING A PASSWORD

By selecting code word **PR**, you can enter a password required for parameterisation. Once the password has been entered - **19**, the name of the first group of parameters is displayed **R--** (alarms). Now, using the buttons UP and DOWN you can select any of the parameter groups quickly.











R-- ALARMS

Once you have selected a parameter group, it will normally be sufficient if you press the button SET (--- will be displayed) and then release the button again. Now, the first parameter of the group will be displayed (parameter **R0** in parameter group **R--**, for example).

Using the buttons UP and DOWN you can scroll the parameter group and change certain parameter values using the default value setting method. Press buttons UP and DOWN at the same time to quit any parameter group and return to the list of parameter groups. To quit the list of parameter groups

and return to the standard level, press buttons UP and DOWN at the same time.

In some cases, certain parameter groups may be protected by a password. In this case, you will have to enter a specific password for the parameter group like in the case of activation of the parameterisation level.

		R--	Alarms
	*	b--	Buttons and switching inputs
		c--	Control circuits 1
		d--	Defrosting control circuits 1
		F--	Fan control circuits 1
		H--	Temperature sensors
	*	J--	Pre-defined sets of parameters
	*	L--	Networking and display
	*	U--	Relay contacts and lamps
	*	y--	Control circuit 2
	*		These levels by default are protected by a password.

R-- Alarms

Parameter	Description of function	Setting range	Default value	
R0	Assignment of alarm sensors, detailed description of sensors in parameters H11 through H53	0: none 1: Sensor F1 2: Sensor F2 3: Sensor F3 4: Sensor F4 5: weighted mean value from F1 and F2	1	
R1	Upper limit value	+0.1...+99.0°C (0.0: inactive)	10.0	
R2	Lower limit value	-99.0...-0.1°C (0.0: inactive)	-10	
R3	Switching mode of alarm relay	0: on if alarm present (normal) 1: off if alarm present (inverse)	1	
R4	Switching hysteresis for alarm	0.1...15.0°C	2,0	
R6	Upper absolute alarm limit	R7 ... 999 °C	150	
R7	Lower absolute alarm limit	-99 ... R6 °C	-99	
R10	Alarm suppression time after temperature alarm	0...240 min.	10	
R11	Alarm suppression time after defrosting	0...240 min	15	
R12	Alarm suppression time after control ON or change of setpoint and/or alarm limits	0...300 min.	180	
R13	Alarm suppression time, door open	0: no alarm 1 ... 600 sec.	180	
R14	Behavior if temperature alarm disappears again	0: without buzzer, delete automatically 1: with buzzer, delete automatically 2: without buzzer, with acknowledgment 3: with buzzer, with acknowledgment	1	
R15	Function buzzer and/or display in the case of alarm (temperature alarm see R14)	0: no display, no buzzer 1: display flashing only 2: buzzer active only 3: display flashing, buzzer active 4: like 2., can be acknowledged 5: like 3., buzzer can be acknowledged 6: like 5., recurring after R16	5	
R16	Buzzer recurring after acknowledgment	1 ... 120 min.	30	
R17	Reset MIN / MAX memory	0: - 1: reset MAX memory 2: reset MIN memory 3: reset MAX and MIN memory	0	
R18	Display of current MAX memory	Measured value, not adjustable		
R19	Display of current MIN memory	Measured value, not adjustable		
R20	Function of high-pressure switch Releases until permanent alarm	0: no permanent alarm 1..10 : releases per 15 min.	0	
R25	Function of low-pressure switch Releases until permanent alarm	0: no permanent alarm 1...300 sec.	0	
R65	Alarm messages via ST-Bus during Standby	see table at parameter description	18	
R99	Password of parameter level R--	-99 ... 999	0	



Buttons and switching inputs (password-protected)

Parameter	Description of function	Setting range	Default value	
b1	Function of key T1	0: without function 1: controller on/standby 2: defrosting request 3: Acknowledge alarm 4: Relay function light 1, not active in standby 5: Relay function light 1, independent of standby 6: Relay function light 2, not active in standby 7: Relay function light 2, independent of standby 8: Relay function window heating, not active in standby 9: Relay function window heating, independent of standby 10: Relay function blade scraper, not active in standby 11: Relay function blade scraper, independent of standby 12: Relay function door frame heating, not active in standby 13: Relay function door frame heating, independent of standby 14: Relay function F, not active in standby 15: Relay function F, independent of Standby 16: Set1 / Set2 - changeover 17: Day / Night - changeover 18: "Superfrost" on/off 19: Evaporator fan permanently on 20: Control circuit 1 on/off 21: Control circuit 2 on/off 22: Set for setpoint Y1 23: display MIN 24: display MAX 25: display sensor F1 26: display sensor F2 27: display sensor F3 28: display sensor F4 29: display sensor F5 30: reset both MIN/MAX 31: reset MIN 32: reset MAX 33: set time 34: set date 35: like 22 + switch display 36: like 16 + remember state 37: like 5 + remember state 38: like 7 + remember state	2	
b2	Function of key T2	see b1	3	
b3	Function of key T3	see b1	0	
b4	Function of key T4	see b1	0	
b5	Function of key T5	see b1	0	
b6	Function of key T6	see b1	1	
b7	Function of key T7	see b1	0	
b8	Function of key T8	see b1	0	

Parameter	Description of function	Setting range	Default value	
b 11	Function of external switching input E1	0: without function 1: controller on/standby 2: high-pressure alarm (see R20) 3: low-pressure alarm (see R25) 4: door contact (light on, fan off, see R 13) 5: relay function A (light 1), not active in standby 6: relay function A (light 1), regardless of standby 7: relay function B (light 2), not active in standby 8: relay function B (light 2), regardless of standby 9: relay function C (window heating), not active in standby 10: relay function C (window heating), regardless of standby 11: relay function D (blade scraper), not active in standby 12: relay function D (blade scraper), regardless of standby 13: relay function E (door frame heating), not active in standby 14: relay function E (door frame heating), regardless of standby 15: relay function F, not active in standby 16: relay function F, regardless of standby 17: Set1 / Set2 change-over 18: day / night change-over 19: "super-frost" on/off (see c2 1...c23) 20: evaporator fan on permanently 21: defrosting request circuit 1 22: defrosting request circuit 2 23: control circuit 1 on/off 24: control circuit 2 on/off 25: like 17 + remember state 26: like 5 + remember state 27: like 7 + remember state	0	
b 12	Switching input E1 inverse / not inverse	0: normal 1: inverse	0	
b 13	Function E2	see b 11	0	
b 14	E2 inverse / not inverse	see b 12	0	
b 15	Function E3	see b 11	0	
b 16	E3 inverse / not inverse	see b 12	0	
b 17	Function E4	see b 11	0	
b 18	E4 inverse / not inverse	see b 12	0	
b99	Password parameter level b--	-99 ... 999	-19	

c-- Control circuit 1

Parameter	Description of function	Setting range	Default value	
c0	Assignment of cold store sensors, detailed description of sensors in parameters H 11 through H53	0: none 1: Sensor F1 2: Sensor F2 3: Sensor F3 4: Sensor F4 5: weighted mean value from F1 and F2	1	
c 1	Setpoint for Set1	c8...c 7	0.0	
c2	Night setpoint (relative to current setpoint c 1 / c3)	-20 ... +20.0°C	5.0	
c3	Setpoint for Set2	c8...c 7	2.0	
c4	Switching mode	0: heating 1: refrigerating	1	
c5	Hysteresis	0.1...15.0°C	2.0	
c6	Hysteresis mode	0: symmetrical 1: one-sided	1	

Parameter	Description of function	Setting range	Default value	
c7	Upper setpoint limit	c8...+99°C	50.0	
c8	Lower setpoint limit	-99°C...c7	-50	
c10	Start protection after compressor start	0 ... 900 sec.	300	
c11	Start protection after compressor stop	0 ... 900 sec.	180	
c12	Start protection compressor after mains on	0 ... 60 min.	0	
c13	Additional condition: compressor off if evaporator sensor < c13	-99 ... 50.0 °C	-99	
c14	Hysteresis for c13	0.1 ... 15.0 K	2.0	
c15	On-time in emergency operation	0 ... 100%	50	
c16	Cycle time in emergency operation	5 ... 60 min.	10	
c20	Assignment of sensor for "super-frost" (also core or product temperature) detailed description of sensors in parameters H11 through H53	0: none 1: Sensor F1 2: Sensor F2 3: Sensor F3 4: Sensor F4 5: weighted mean value from F1 and F2	1	
c21	"super-frost": time limit ("shock-frost", "max. cooling power")	1 ... 36 hrs.	10	
c22	"super-frost": temperature limit ("shock-frost", "max. cooling power")	-40 ... 0°C	0.0	
c23	"super-frost": automatic off ("shock-frost", "max. cooling power")	0: none, manual only 1: controlled by time 2: controlled by time or temperature	2	
c30	Assignment of humidity sensor, detailed description of sensors in parameters H11 through H53	0: none 1: Sensor F1 2: Sensor F2 3: Sensor F3 4: Sensor F4 5: weighted mean value from F1 and F2	0	
c31	Humidity setpoint for Set1	c40 ... c39	50%	
c32	Night setpoint, humidity (relative to c31)	-20 ... +20 %	0	
c33	Humidity setpoint for Set2	c40 ... c39	50%	
c34	Humidity mode	0: off 1: evaporator fan on (continuous operation) 2: Moisturize 3: Dehumidification with counter-heating	1	
c35	Hysteresis humidity	0.1% ... 15.0 %	5,0%	
c36	Hysteresis mode humidity	0: symmetrical 1: one-sided	1	
c37	Setpoint offset counter-heating for dehumidification (relative to cold store setpoint c1/c2/c3)	-15.0 ... 0.0 K	-0,5	
c38	Hysteresis for c37 (one-sided above)	0.1 ... 10.0 K	1,0 K	
c39	Upper setpoint limit c31/c33	c40 ... 100%	100%	
c40	Lower setpoint limit c31/c33	0,0% ... c37	0,0%	
c99	Password of parameter level c--	-99 ... 999	0	



Defrosting control circuit 1

Parameter	Description of function	Setting range	Default value	
d0	Assignment of evaporation sensors (defrosting sensors) detailed description of sensors in parameters H11 through H53	0: none 1: Sensor F1 2: Sensor F2 3: Sensor F3 4: Sensor F4 5: weighted mean value from F1 and F2	2	
d1	Defrosting interval	1...99 hrs. (0: no automatic defrosting)	8	
d2	Type of defrosting	0: no defrosting 1: compressor off only (circulating air) 2: electrical 3:with hot gas	2	
d3	Stop at defrosting temperature	0 ... +30.0°C	10.0	
d4	Defrosting time limitation	1...99 min.	30	
d7	Temperature difference to cold store setpoint in previous cooling	-15°C ... 0.0°C	0.0	
d8	Time limitation in previous cooling	1 ... 180 min.	10	
d9	Delay of start of defrosting after compressor off d2=2	0 ... 900 sec.	60	
d10	Dripping time	0 ... 15 min.	1	
d11	Stop delay drip tray heating	0 ... 60 min.	10	
d20	Display, forced release after defrosting	0 ... 60 min. (0 = deactivated)	0	
d99	Password of parameter level d--	-99 ... 999	0	



Fan control circuit 1

Parameter	Description of function	Setting range	Default value	
F8	Fan speed control mode, Set1	0 ... 100%	80.0	
F9	Fan speed defrosting, Set1	0 ... 100%	80.0	
F10	Fan speed control mode, Set2	0 ... 100%	100	
F11	Fan speed defrosting, Set2	0 ... 100%	100	
F12	Start-up time	0 ... 60 sec.	5	
F13	Minimum speed (output variable if result=0)	0 ... 100%	10.0	
F15	Evaporator fan Fan mode normal operation Remark: Control setpoint if F15>4 is c1 or c3	0: off 1: continuous operation 2: like 1, with drip interruption 3: with compressor on 4: temperature-controlled, evaporator sensor only 5: temperature-controlled, difference between cold store and evaporator sensor	3	
F16	Evaporator fan Fan mode defrosting	0: off 1: on	0	
F17	Evaporator fan, delay after compressor start	0 ... 600 sec.	0	
F18	Evaporator fan, delay after defrosting	0 ... 600 sec.	120	
F19	Evaporator fan, drip interruption time if F15=2	0 ... 600 sec.	180	
F20	Evaporator fan, control offset if F15=4 or 5	-15.0 ... +15.0°C	0.0	
F21	Evaporator fan, control hysteresis if F15=4 or 5	0.1 ... 15.0°C	2.0	
F22	Fan speed control mode, Set1, NIGHT	0 ... 100%	90.0	
F23	Fan speed control mode, Set2, NIGHT	0 ... 100%	50.0	
F50	Assignment of condenser sensors detailed description of sensors in parameters H11 through H53	0: none 1: Sensor F1 2: Sensor F2 3: Sensor F3 4: Sensor F4 5: weighted mean value from F1 and F2	0	
F51	Condenser fan setpoint	-55...+150°C	60.0	
F54	Condenser fan switching hysteresis (only if F65 = 3)	0.1...15.0°C	10.0	
F58	Condenser fan, delay after compressor start	0...300 sec.	60	
F59	Condenser fan, delay after compressor stop (overrun)	0...600 sec.	300	
F65	Condenser fan function	0: always off 1: always on 2: on if compressor on 3: after setpoint F70 4: like 3, (setpoint F70), as P controller	2	
F66	Proportional range P-controller if F65=4	0.1 ... 30.0°C	10.0	
F67	Minimum speed (output PWM if result =0)	0 ... 100 %	10.0	
F68	Condenser fan start-up time	0 ... 60 sec.	10	
F99	Password of parameter level F--	-99 ... 999	0	



H--

Temperature sensors

Parameter	Description of function	Setting range	Default value	
H 1	Mains frequency	0: 50Hz 1: 60Hz	0	
H 11	Act. value sensor F1	Measured value, not adjustable		
H 12	Calibration sensor F1 (actual value correction)	-20...+20.0°C	0,0	
H 13	Weighting factor sensor F1	0.50...1.50	1,00	
H 14	Selection sensor F1 Depending on hardware, not all types are available. Sensor will be deactivated in this case.	0: not existing 1: PTC (-50...+150°C) 2: Pt100 2-wire (-100...+600°C) 3: Pt100 3-wire (-100...+500°C) 4: NTC (-40...+40°C) 5: Pt1000 2-wire (-100...+330°C) 6: Pt1000 3-wire (-100...+300°C) 7: 0-20mA 8: 4-20mA	1	
H 15	Software filter sensor F1	1 .. 32	8	
H 16	Display at 0/4mA and sensor selection H 14=7/8	-99...+999	0,0	
H 17	Display at 20 mA and sensor selection H 14=7/8	-99...+999	100	
H 21	Act. value sensor F2	Measured value, not adjustable		
H 22	Calibration sensor F2 (act. value correction)	-20...+20,0°C	0,0	
H 23	Weighting factor sensor F2	0,50...1,50	1,00	
H 24	Selection sensor F2	see H 14	1	
H 25	Software filter sensor F2	1 .. 32	8	
H 26	Display at 0/4mA and sensor selection H 24=7/8	-99...+999	0,0	
H 27	Display at 20 mA and sensor selection H 24=7/8	-99...+999	100	
H 31	Act. value sensor F3	Measured value, not adjustable		
H 32	Calibration sensor F3 (act. value correction)	-20...+20,0°C	0,0	
H 33	Weighting factor sensor F3	0,50...1,50	1,00	
H 34	Selection sensor F3	see H 14	0	
H 35	Software filter sensor F3	1 .. 32	8	
H 36	Display at 0/4mA and sensor selection H 34=7/8	-99...+999	0,0	
H 37	Display at 20 mA and sensor selection H 34=7/8	-99...+999	100	
H 41	Act. value sensor F4	Measured value, not adjustable		
H 42	Calibration sensor F4 (act. value correction)	-20...+20,0°C	0,0	
H 43	Weighting factor sensor F4	0,50...1,50	1,00	
H 44	Selection sensor F4	see H 14	0	
H 45	Software filter sensor F4	1 .. 32	8	
H 46	Display at 0/4mA and sensor selection H 44=7/8	-99...+999	0,0	
H 47	Display at 20 mA and sensor selection H 44=7/8	-99...+999	100	
H 51	Display of weighted mean value of F1+F2 $H 51 = (H 53 * H 11 + (100 - H 53) * H 21) / 100$			
H 53	Weighting of sensor F1 for H 51	0 ... 100%	100	
H 99	Password of parameter level H--	-99 ... 999	0	



Pre-defined parameter sets (password protected)

Parameter	Description of function	Setting range	Default value	
J1	Parameter set	0 ... 5	0	
J2	Parameter reset	0 ... 31 (see parameter description)	0	
J98	Password for entering the level selection (when PR is displayed)	-99 ... 999	-19	
J99	Password of parameter level J--	-99 ... 999	-19	

If required, various preset parameter sets can be realized by means of **J1**.

The parameter **J98** is only visible and adjustable via the ST-Bus.

Attention: A change of the parameter set changes all parameter settings!



Networking and display (password protected)

Parameter	Description of function	Setting range	Default value	
L0	Own address ST-bus (identical to setting Adr)	0: deactivated 1 ... 250	1	
L2	Temperature scale	0: °C 1: °F	0	
L3	Display mode	0: 3 digits, integers 1: 3 digits, rounded to 0.5 2: 3 digits, 0.1 3: 4 digits, integers 4: 4 digits, rounded to 0.5 5: 4 digits, 0.1	2	
L4	Display value	See actual values table	0	
L6	Software version			
L7	Display in standby mode	0: OFF 1: RUS 2: right decimal point 3: right decimal point flashing	1	
L40	ST bus release mask for functions	0 .. 255	249	
L41	ST bus release mask for functions	0 .. 255	255	
L42	Release for a deletion of the counter/runtimes	0: no release 1: Deletion is approved for 10 min (see R17 , N98 , T98 , J2)	0	
L99	Password of parameter level L--	-99 ... 999	-19	

Relay contacts and lamps (password-protected)

Parameter	Description of function	Setting range	Default value	
U1	Function relay K1	0: no function (off) 1: compressor 2: defrosting circuit 1 3: evaporator fan 4: condenser fan 5: alarm 6: control contact circuit 2 7: defrosting circuit 2 8: relay function A (light 1) 9: relay function B (light 2) 10: relay function C (window heating) 11: relay function D (door frame heating) 12: relay function E (blade scraper) 13: relay function F 14: drip tray heating 15: buzzer 16: on if controller active 17: on if control circuit 1 active 18: on if control circuit 2 active 19: on if Set 1 active 20: on if Set 2 active 21: on if day mode active 22: on if night mode active 23: on if Superfrost active 24: Counter-heating during dehumidification 25: Humidify	1	
U2	Function relay K2	see U1	2	
U3	Function relay K3	see U1	3	
U4	Function relay K4	see U1	5	
U5	Function relay K5	see U1	0	
U6	Function relay K6	see U1	0	
U7	Function relay K7	see U1	0	
U8	Function relay K8	see U1	0	
U11	Function LED1	0: no function (off) 1: compressor/magnetic valve 2: defrosting control circuit 1 3: evaporator fan 4: condenser fan 5: alarm 6: control circuit 2 7: defrosting circuit 2 8: Light 1 9: Light 2 10: window heating 11: blade scraper 12: door frame heating 13: relay function F 14: drip tray heating 15: "super-frost" 16: "humidity" 17: control circuit 1 active 18: control circuit 2 active 19: set 1 active 20: set 2 active 21: day mode active 22: night mode active 23: display "MIN" 24: display "MAX"	1	

Parameter	Description of function	Setting range	Default value	
U 11	Function LED1	25: Display circuit 1 active 26: Display circuit 2 active 27: Controller active 28: Counter-heating during dehumidification 29: Humidify		
U 12	Function LED2	see U 11	2	
U 13	Function LED3	see U 11	3	
U 14	Function LED4	see U 11	0	
U 15	Function LED5	see U 11	0	
U 16	Function LED6	see U 11	0	
U 17	Right decimal point	see U 11	0	
U 20	Function LED week days	0: no function (off) 1: display weekday 2: see U 21...U 27	0	
U 21	Function LED7 (Mo)	see U 11	0	
U 22	Function LED8 (Tu)	see U 11	0	
U 23	Function LED9 (We)	see U 11	0	
U 24	Function LED10 (Th)	see U 11	0	
U 25	Function LED11 (Fr)	see U 11	0	
U 26	Function LED12 (Sa)	see U 11	0	
U 27	Function LED13 (Su)	see U 11	0	
U 99	Password of parameter level U--	-99 ... 999	-19	

Control circuit 2 (password protected)

Parameter	Description of function	Setting range	Default value	
Y 0	Assignment of sensors to control circuit 2 detailed description of sensors in parameters H 11 through H 53	0: none 1: Sensor F1 2: Sensor F2 3: Sensor F3 4: Sensor F4 5: weighted mean value from F1 and F2	0	
Y 1	2nd control circuit: setpoint	Y 8...Y 7	10,0	
Y 2	2nd control circuit: absolute setpoint or DeltaW	0: absolute 1: DeltaW	1	
Y 4	2nd control circuit: switching mode	0: heating 1: refrigerating	1	
Y 5	2nd control circuit: hysteresis	0.1...99.0°C	2,0	
Y 6	2nd control circuit: hysteresis mode	0: symmetrical 1: one-sided	1	
Y 7	Upper setpoint limit	Y 8 ... +999°C	50,0	
Y 8	Lower setpoint limit	-99°C ... Y 7	-50	
Y 9	Function in the case of sensor fault	0: contact off 1: contact on	1	
Y 10	Defrosting interval control circuit 2	0: no defrosting 1...99 hrs.	0	
Y 11	Defrosting time limitation thermostat 2	1...99 min.	30	
Y 99	Password of parameter level Y--	-99 ... 999	-19	

N level (counters)

This level contains the parameters for counters. Parameters only accessible via the ST-Bus.

Parameter	Description of function	Setting range		
N0	Switching cycles of K1 (lower 16bit)	—		
N1	Switching cycles of K1 (upper 16bit)	—		
N2	Switching cycles of K2(lower 16bit)	—		
N3	Switching cycles of K2 (upper 16bit)	—		
N4	Switching cycles of K3 (lower 16bit)	—		
N5	Switching cycles of K3 (upper 16bit)	—		
N6	Switching cycles of K4 (lower 16bit)	—		
N7	Switching cycles of K4 (upper 16bit)	—		
N8	Switching cycles of K5 (lower 16bit)	—		
N9	Switching cycles of K5 (upper 16bit)	—		
N10	Switching cycles of K6 (lower 16bit)	—		
N11	Switching cycles of K6 (upper 16bit)	—		
N12	Switching cycles of K7 (lower 16bit)	—		
N13	Switching cycles of K7 (upper 16bit)	—		
N14	Switching cycles of K8 (lower 16bit)	—		
N15	Switching cycles of K8 (upper 16bit)	—		
N98	Deleting the relay switching cycles	0: - 1: reset	0	
N99	Password of parameter level N	-99 ... 999	0	

The number of switching cycles is calculated as follows (i.e. for K1): number = 65536 * N1 + N0. Parameter N98 resets the counters for all relays. It depends on the setting of parameter [L42](#). The return value is set back to "0" automatically.

T level (operating times)

This level contains the parameters for operating times. Parameters are only accessible via the ST-Bus.

Parameter	Description of function	Setting range		
T10	Total operating time (lower 16 bit)	—		
T11	Total operating time (upper 16 bit)	—		
T12	Operating time since last reset (lower 16 bit)	—		
T13	Operating time since last reset (upper 16 bit)	—		
T14	On-time relay "Compressor" (lower 16 bit)	—		
T15	On-time relay "Compressor" (upper 16 bit)	—		
T16	On-time relay "defrosting 1" (lower 16 bit)	—		
T17	On-time relay "defrosting 1" (upper 16 bit)	—		
T18	On-time relay "evaporator fan" (lower 16 bit)	—		
T19	On-time relay "evaporator fan" (upper 16 bit)	—		
T20	On-time relay "condenser fan" (lower 16 bit)	—		
T21	On-time relay "condenser fan" (upper 16 bit)	—		
T22	On-time relay "thermostat 2" (lower 16 bit)	—		
T23	On-time relay "thermostat 2" (upper 16 bit)	—		
T24	On-time relay "defrosting 2" (lower 16 bit)	—		
T25	On-time relay "defrosting 2" (upper 16 bit)	—		
T26	On-time relay "drip tray heating" (lower 16 bit)	—		
T27	On-time relay "drip tray heating" (upper 16 bit)	—		
T28	On-time relay function A: light 1 (lower 16 bit)	—		
T29	On-time relay function A: light 1 (upper 16 bit)	—		

Parameter	Description of function	Setting range		
T30	On-time relay function B: light 2 (lower 16 bit)			
T31	On-time relay function B: light 2 (upper 16 bit)			
T32	On-time relay function C (lower 16 bit)			
T33	On-time relay function C (upper 16 bit)			
T34	On-time relay function D (lower 16 bit)			
T35	On-time relay function D (upper 16 bit)			
T36	On-time relay function E (lower 16 bit)			
T37	On-time relay function E (upper 16 bit)			
T38	On-time relay function F (lower 16 bit)			
T39	On-time relay function F (upper 16 bit)			
T98	Reset operating hours	0: - 1: reset	0	
T99	Password for T-level	-99 ... 999	0	

The operating time is calculated as follows: Operating time (in minutes) = 65536 * T11 + T10.

Parameter T98 resets the counters for all operating times (except for T10 and T11). It depends on the setting of parameter [L42](#). The return value is set back to "0" automatically.

EC level (Reserved for internal use)

The level is accessible only via the ST bus.

MASTER PASSWORD

All passwords can be edited through parameterisation. If you don't remember a password, you can still parameterise the controller and look up and/or edit the password via a master password. To do that, follow these steps:

1. Switch off power supply (disconnect from mains or switch off power supply unit)
2. Press buttons UP, DOWN and SET at the same time and switch on power supply again.
3. Now, a ("Challenge") number will be displayed for approx. 5s.

In no case disconnect the controller from power supply now. Otherwise, the number will become invalid. Using this number, you can call our sales staff, phone +49 711 68661-0 to request the master password ("Response"). Enter this master password in the 1st control level in [PR](#).

Important: Even if you remember the password, you must enter the master password here. If the password is accepted, you will enter the parameter selection levels and all passwords will be deactivated. By pressing the SET button (display ---) you can switch to the relevant parameter level.

Now, the master password is no longer required. The passwords will remain deactivated until the controller is disconnected from power supply again. In case you leave the parameter level now, simply press the SET button in [PR](#) in order to access the parameter selection levels again.

STATUS DISPLAY AND ERROR MESSAGES

Message	Cause	Remedy
H i	Over-temperature, temperature above alarm limit of parameter R1/R31	
Lo	Under-temperature, temperature below alarm limit of parameter R2/R33	
E1L	Error on sensor F1, short-circuit	check sensor F1
E1H	Error on sensor F1, wire broken	check sensor F1
E2L	Error on sensor F2, short-circuit	check sensor F2
E2H	Error on sensor F2, wire broken	check sensor F2
E3L	Error on sensor F3, short-circuit	check sensor F3
E3H	Error on sensor F3, wire broken	check sensor F3
E4L	Error on sensor F4, short-circuit	check sensor F4
E4H	Error on sensor F4, wire broken	check sensor F4
E5	Door open for too long	close door
E6	High-pressure fault	Check: Condenser fan and check for dirt accumulation
E7	Low-pressure fault	Plant leaking, to little coolant
EP0	Internal error in control unit	Repair control unit
EP1	Error in parameter memory	Check all parameters
EP2	Error in data memory	Repair control unit
rbc	Error of internal clock	Set clock again. If error occurs again, the controller must be repaired

The **EP0** and **EP1** errors disable the controller. The controller is not enabled until the error has been eliminated.

The error **EP0** (and **EP2**) can only be removed by repair.

The errors are displayed alternately with the currently measured temperature.

A-- Alarms

A0 Alarm sensor assignment

With this parameter, you can set which sensor input is to be used as the alarm sensor.

A1 Upper limit value

A2 Lower limit value

The limit values are used for monitoring the cold store temperature. They are relative values, i.e. they always refer to the setpoint S1. If the temperature increases above or falls below the upper and lower limits, an alarm as specified in A15 will be triggered. If A1 = 0 and/or A2 = 0, the relevant limit alarm is deactivated.

A3 Switching mode of alarm relay

With this parameter you can define if the relay is to be closed or opened in the case of an alarm.

A4 Switching hysteresis for alarm

The alarm contact hysteresis is set asymmetrically, downward at the upper alarm value and upward at the lower alarm point.

A6 Absolute upper limit value

A7 Absolute lower limit value

The absolute limit values are used for monitoring the cold store temperature. They are absolute values. If the temperature increases above or falls below the upper and lower limits, an alarm as specified in A15 will be triggered after the time set with A10. To ignore these limits, the values must be set to a temperature outside the active cold room working range.

A10 Alarm suppression time after temperature alarm

If the temperature of the cold store exceeds the limits set in A1, A2, a temperature alarm should normally be triggered. Based on the suppression time set in A10, triggering of the alarm can be delayed.

A11 Alarm suppression time after defrosting

Triggering of a temperature alarm is prevented for the set time after defrosting so that the plant can reach normal operating conditions again.

A12 Alarm suppression time after Refrigeration On

Triggering of an alarm is suppressed for the set time after activation of refrigeration. This is to allow the refrigerating plant to reach the working temperature range without triggering of an alarm.

A13 Alarm suppression time, door open

With this parameter you can define after which time an alarm is to be triggered when the door is opened. If the door is closed again within the specified time, no alarm will be triggered.

A14 Behavior when temperature alarm disappears

Here, you can define if a temperature alarm can be deleted automatically as soon as the temperature is in the permissible range again or if it must be acknowledged. This is to ensure, for example, that a temperature alarm that occurred at night remains present until the error is acknowledged the next day. If the temperature alarm is still present when it is acknowledged, the buzzer will be switched off as set in A15, the alarm message in the display, however, will remain present until the temperature is within the permissible range again. Then, the acknowledged alarm will be deleted automatically.

A15 Buzzer function and/or display in the case of an alarm

Here, you can define if a temperature alarm is to be displayed or not and if the buzzer is to sound. Additionally, you can define if the buzzer is to sound again after acknowledgment. The corresponding time is indicated in A16. The error message and the temperature will be displayed alternately as long as the alarm is present. If more than one alarm messages are present, they will be displayed alternately. The alarm relay will signal the alarm at all times.

A16 Buzzer recurring after acknowledgment

Alarms which have not been eliminated will be switched on again by the buzzer after the set time. This only applies if A15=6.

A17 Reset MIN / MAX memory

With this parameter, you can delete the MIN and/or MAX memory.

A18 Display of current MAX memory

Here, you can view the current MAX memory.

A19 Display of current MIN memory

Here, you can view the current MIN memory.

A20 High-pressure function: Releases until alarm

In the case of a high-pressure signal via a parameterised switching input, the compressor will be switched off immediately and a message will be displayed. If the high-pressure signal disappears within 15 minutes, the error message will be deleted and the compressor will be started again. However, an alarm via the alarm relay will only be triggered if the number of registered releases (within 15 min.) set in this parameter is exceeded or if the signal is present for more than 15 minutes. This fault will only be deleted after disconnection of the plant from mains supply (and repair!).

A25 Low-pressure function:

Delay until alarm

If a low-pressure signal is present via a parameterised switching input and it does not disappear again within the time specified here, the compressor will be switched off and an error message will be displayed. This fault will only be deleted after disconnection of the plant from mains supply (and repair!).

A25 Alarm messages via ST-Bus during Standby

A binary mask selects the alarm messages, which are enabled for the ST-Bus during Standby.

The bits have the following meanings:

Bit	Value	Function
0	+1	Temperature alarm (Hi, Lo)
1	+2	Sensor error
2	+4	High pressure alarm
3	+8	Low pressure alarm
4	+16	Door alarm
5		not used
6		not used
7		not used

To determine the value to be parameterised, all bit values must be added together. In the factory setting (A65 = 18) door alarm and sensor errors are allowed.

A99 Password for parameter level A--

With this parameter, you can set the password for parameter level A--.

b-- Buttons and switching inputs

(password-protected)

b1 ... b8 Function buttons 1 ... 8

Certain functions can be assigned to the buttons. The buttons are arranged according to the front foil, the layout may differ from case to case. For the function of the buttons, refer to the operating manual of the relevant device. The "SET" cannot be assigned another function!

b11, b13, b15, b17 Function E1 ... E4

Certain functions can be assigned to the switching inputs.

b12, b14, b16, b18 Switching mode E1 ... E4

Here, you can define if the switching input is used as a make contact (normal) or break contact (inverse).

b99 Password for parameter level b--

With this parameter, you can set the password for parameter level b--.

c-- Control circuit 1

c0 Assignment of cold store sensors

With this parameter, you can set which sensor input is to be used as the cold room sensor. The selected sensor must be set up accordingly in the parameters.

c1 Control circuit 1: Setpoint (Set1)

c2 Circuit 1: Night-time incr./decr.

c3 Control circuit 1: Setpoint (Set2)

With this parameter, you can set the setpoint. It will be displayed directly if you press the SET button and can be edited. The setting range is defined by the settings in parameters c7 and c8. Setpoint c3 becomes active if the Set2 function is switched on via a button, a digital switching input, the internal clock or the ST-bus. Setpoint c2 becomes active if the night-time increase/decrease function is switched on via a button, a digital switching input, the internal clock or the ST-Bus. The value of c2 is added to the currently active setpoint c1 or c3.

c4 Control circuit 1: Switching mode

The switching mode of the control output can be set to heating or refrigerating function. In the case of the heating function, the control output is switched on if the actual temperature is lower than the set temperature. In the case of the refrigerating function, the output is on if the temperature is higher than the setpoint.

c5 Control circuit 1: Hysteresis

In this parameter, you can specify the control hysteresis. A small hysteresis enables exact control, but will result in frequent switching of the relay.

c6 Hysteresis mode

With this parameter you can define if the hysteresis will be active at the corresponding switching point symmetrically or on one side only. In the case of a one-sided hysteresis, the hysteresis will be active below the setpoint in the case of the heating function [c4=0] and above the setpoint in the case of the refrigerating function [c4=1]. In the case of a symmetrical hysteresis, there is no difference.

c7 Upper setpoint limit

c8 Lower setpoint limit

Setpoints c1 and c3 can only be set within the limits defined here.

c10 Start protection after compressor start

This protection time starts as soon as the compressor is switched on. When the compressor is switched off, it cannot be switched on again until this time has elapsed. This is to avoid excessive activation and to increase the service life as a consequence.

c11 Start protection compressor after compressor stop

This protection time starts as soon as the compressor is switched off. The compressor cannot be switched on again until this time has elapsed. This is to avoid excessive activation and to increase the service life as a consequence.

c12 Start protection compressor after mains On

Activation of the control output is prevented after "Mains On" until this time has elapsed. This function can be used, for example, to avoid that several controllers are switched on at the same, which would result in a high load on the power supply network.

c15 On-time in emergency operation

c16 Cycle time in emergency operation

With these parameters, you can define how the compressor is to behave in the case of a sensor fault. In emergency operation, the compressor is operated in a cycle of c16. The on-time in c15 is a percentage of the cycle time, with 100% meaning that the compressor runs continuously and 0% meaning that the compressor is off all the time. In deep-freeze stores, the compressor should continue operation in order to avoid defrosting. In normal cold stores above 0°C continued operation might result in frost damage, however. During emergency operation, no defrosting will be performed.

c20 Assignment of sensors for "super-frost" function

With this parameter, you can set which sensor input is to be assigned to the "super-frost" function. Depending on the sensor design, it can also be used as core and/or product temperature sensor. The selected sensor must be set up accordingly in the H parameters.

c21 "super-frost": lime limit,

"shock-frost", max. refrigerating power

c22 "super-frost": temperature limit,

"shock-frost", max. refrigerating power

c23 "super-frost": deactivation,

"shock-frost", max. cooling power

If this function is activated, the lower warning limit is deactivated and the compressor is on permanently. In c23, you can define if automatic shut-down is to be performed and if this automatic shut-down is to be limited by time only or by temperature, too. Limitation by time is defined via c21, the temperature condition is defined via c22.

c30 Assignment of sensor for humidity control

With this parameter, you can set which sensor input is to be assigned for the humidity. If no sensor is assigned, the humidity control will be disabled. However, the function c34 = 2 can be used to switch a relay via the humidity function button. The selected

sensor must be set up accordingly in the H parameters.

c31 Setpoint humidity (Set1)

c32 Setpoint offset humidity at night

c33 Setpoint humidity (Set2)

For c34 >= 2 and assigned sensor, the value set here is used for control. The value in parameter c32 is added to c31 when night mode is active.

c34 Humidity control mode

In the setting c34=1 only the evaporator fan is set to continuous operation for humidification. As a result, the humidity that forms on the evaporator is transported back into the cold room. The function is switched manually via the Humidity function (see b parameter). In the setting c34=2, a relay is switched for humidification, which distributes moisture in the form of e.g. mist in the cold room. If no sensor is specified, this relay can be switched manually via the Humidity function (see b parameter). In the setting c34=3 the compressor is switched on for dehumidification. So that the cold room does not get too cold, a counter heating is switched according to c37 and c38. If no sensor is specified, this function is deactivated.

c35 Hysteresis

In this parameter, you can specify the control hysteresis. A small hysteresis enables exact control, but will result in frequent switching of the relay.

c36 Hysteresis mode humidity

With this parameter you can define if the hysteresis will be active at the corresponding switching point symmetrically or on one side only. A single-sided programmed hysteresis is intended for a moistening [c34=2] below and a dehumidification [c34=3] above the setpoint. In the case of a symmetrical hysteresis, there is no difference.

c37 Switch-on point counter-heating

c38 Switch-off point counter-heating

In the dehumidification function [c34=3] the compressor is activated in order to reduce the moisture in the cold store. A counter-heating can be activated, to avoid the cooled from getting too cold. To do this, the value in c37 is added to the current cold store setpoint and if the value falls below this calculated value, the counter heating is switched on (see U parameters). At the switch-off point c38 (relative, above c37), the heating is switched off.

c39 Upper humidity setpoint limit

c40 Lower humidity setpoint limit

Setpoints c31 and c33 can only be set within the limits defined here.

c99 Password for parameter level c--

d-- Defrosting control circuit 1

d0 Assignment of evaporator sensor (defrosting sensor)

With this parameter, you can set which sensor input is to be used as the evaporator/defrosting sensor. The selected sensor must be set up accordingly in the **H** parameters.

d1 Defrosting interval

The defrosting interval defines the time after which a defrosting operation is started. Once the defrosting operation is triggered, the defrosting interval starts again. A defrosting operation can also be triggered by pressing the UP button ("manual defrosting") for at least 3 seconds or another parameterised button. Via the internal week timer, defrosting can also be started in real time. Once switched on, the controller starts refrigeration immediately and will trigger the first defrosting operation as soon as the time set in **d1** has elapsed. If **d1**=0, no automatic defrosting operation will be performed.

d2 Defrosting mode

In this parameter, you can define if defrosting is to be performed and, if yes, how it is to be performed. You can choose among simple shut-down of the compressor, defrosting by electric heating or by hot gas. Electric defrosting will always be performed after a compressor break, defined in **d9**. Hot gas defrosting will always be performed directly after a refrigeration phase. Additionally, you can define via parameters **d7** and **d8** if the cold store temperature is to be lowered before defrosting.

d3 Defrosting temperature

A defrosting operation is complete as soon as the temperature set here is reached at the evaporator. If the defrosting operation is not completed within the time set in **d4**, it will be stopped.

d4 Defrosting time limitation

Here, you can set the max. time in which the defrosting operation must be completed. After the time set here, the defrosting operation will be stopped even if the evaporator was not hot enough to be free of ice. No error message will be displayed.

d7 Temperature difference for refrigeration before defrosting

d8 max time for refrigeration before defrosting

To avoid unnecessary heating up of the cold store, you can set up a refrigeration cycle to be performed before the defrosting operation.

d9 Delay after compressor stop before electric defrosting is started

If the compressor is on when an electric defrosting request is received, the start of the

defrosting operation is delayed by the time specified here.

d10 Drip time

Directly after the end of defrosting, the dripping time or drainage time follows in order to let the evaporator drip off. During this time, the compressor, defrost and evaporator fan outputs are switched off.

d11 Off-delay of drip tray heating

Here, you can define how long the drip tray heating is to remain switched on after a defrosting operation to avoid that the dripping water freezes again.

d20 Display, forced release after defrosting

With **L4** = 0, the display can be frozen during defrosting. After successful defrosting the frozen display is released not later than the time set here. If 0 is set, there will be no forced release.

d99 Password for parameter level d--

With this parameter, you can set the password for parameter level d--.

F-- Fan control circuit 1

F8 Fan speed in control mode, Set1

Fan speed in normal control mode and active Set1

F9 Fan speed during defrosting, Set1

Fan speed during defrosting and active Set1

F10 Fan speed in control mode, Set2

Fan speed in control mode and active Set2.

F11 Fan speed during defrosting, Set2

Fan speed during defrosting and active Set1

F12 Start-up time (in seconds)

If necessary, the fan can be switched on at max. speed for the time set here to ensure it runs properly. This parameter is active only if the fan is switched on from standstill.

F13 Minimum speed

Here, you can set the lowest voltage value at which a connected fan will still be running.

F15 Evaporator fan: Fan mode control mode

In this parameter, you can define how the fan is switched on in control mode. If the controller is performing a defrosting operation, the fan will be controlled via parameter **F16**. In the case of continuous operation, the fan will be running as soon as the controller is switched on. In the case of continuous operation interrupted for draining, the fan will behave like in the case of continuous operation. However, it will be switched off for the time set in **F19** as soon as the defrosting operation is complete. After the drain time set in **F19**, the fan will be switched on again.

If the compressor is switched on before this time has elapsed, the fan will be restarted immediately (after the delay set in **F17**). In the configuration with compressor On, the fan will be switched on/off together with the compressor. In order to avoid mains overload by starting the compressor and fan at the same time, a delay can be defined in **F17**. The fan can also be temperature-controlled. You can define if the evaporator sensor temperature or the difference between the evaporator and the cold store sensor is to be used for controlling the fan. The control setpoint and hysteresis are defined via parameters **F20** and **F21**.

F16 Fan mode defrosting

This parameter defines if the fan is to be on or off during defrosting. This parameter will not be effective in temperature-controlled fan mode [**F15**=4 or 5].

F17 Delay after compressor On

In order to avoid mains overload by starting the compressor and fan at the same time, you can define a delay for the fan in this parameter. It will not be effective in temperature-controlled fan mode.

F18 Delay after defrosting

At the end of a defrosting cycle, the fan will be switched on after the delay set in this parameter. This parameter will be effective in all fan modes set up.

F19 Drip interruption time (if F15=2)

If the fan runs in continuous mode, there is low temperature variation at high atmospheric moisture. In operation mode "with compressor on", the temperature variation will be greater while the atmospheric moisture is lower. This parameter is to enable a combination of both advantages. The fan runs in continuous mode and is switched off for the time specified here when the compressor is switched off. This enables the moisture accumulating at the evaporator to drain off.

F20 Control offset evaporator sensor (for F15=4 or 5)

If **F15**=4 the following applies: The setpoint for control circuit 1 (**c1** or **c3**) forms the basis. If the evaporator temperature is below the setpoint, the evaporator fan will be switched on. This switching point can be shifted by the value defined here. If **F15**=5 the following applies: The temperature difference between cold store (sensor from **c0**) and evaporator temperature (sensor from **d0**) determines the switching point for the evaporator fan. If the evaporator temperature is below the cold store temperature, the evaporator fan will be switched on. This switching point can be shifted by the value defined here.

F21 Hysteresis (if F15=4 or 5)

The control hysteresis is always set above the theoretical switching point.

F22 Fan speed in control mode, Set1, NIGHT

Fan speed at night in normal control mode and active Set1

F23 Fan speed in control mode, Set2, NIGHT

Fan speed at night in normal control mode and active Set1

F50 Assignment of evaporator sensor

With this parameter, you can set which sensor input is to be used as the evaporator sensor. The selected sensor must be set up accordingly in the H parameters.

F51 Condenser fan: setpoint

Only effective if F65=3 or 4 and F70=0. If the value defined here is exceeded, the condenser fan will be switched on.

F54 Condenser fan: switching hysteresis

Only effective if F65=3. The hysteresis is set on one side above the setpoint of parameter F51.

F58 Condenser fan: Delay after compressor start

On-delay of condenser fan after activation of the compressor.

F59 Condenser fan: Delay after compressor stop

Off-delay of condenser fan after shut-down of the compressor. This delay is not active if F65 = 3 or .4

F65 Function of condenser fan

0: no function, i.e. condenser fan is off
 1: condenser fan on at all times
 2: condenser fan on if compressor is on
 3: condenser fan controlled via setpoint in parameter F51. In the case of a sensor fault, the fan behaves like F65=2.
 4: like 3., but the fan is controlled continuously via a voltage output
 The proportional range is defined in parameter F66.

F66 Condenser fan: Proportional range P-controller

For setting of proportional range required if F65=4 in which the fan is to be controlled.

F67 Condenser fan: Minimum speed

Here, you can set the lowest voltage value at which a connected fan will still be running.

F68 Condenser fan: Start-up time

Here, you can define the time for which a fan is switched on from standstill at max. voltage to enable stable operation.

F99 Password for parameter level F--

With this parameter, you can set the password for parameter level F--.

H-- Temperature sensors

H1 Mains frequency

In this parameter, you must define the mains frequency.

H11, H21, H31, H41 Actual value sensor F1..F4

The temperature value shown here is used for control. It is calculated as follows:

Actual control value =
 (actual measured value * weighting factor)
 + actual value correction

Actual value correction and weighting factor must be defined in the following parameters. This corrects actual value deviations in special applications (refrigerated shelves or similar) due to unfavourable sensor location.

H51 Weighted mean value sensors F1 and F2

This theoretical mean value from sensors F1 and F2 may be calculated for the control circuit or display. It is calculated as follows:

$$H51 = (H53 \times H11 + (100 - H53) \times H21) / 100$$

H12, H22, H32, H42 Calibration of sensor F1..F4 actual value correction

With this parameter it is possible to correct actual value deviations caused by sensor tolerances, very long sensor cables or structural protections (e.g. ex-barriers), for example. The value defined here is added to the measured value.

H13, H23, H33, H43 Weighting factor F1..F4

With this parameter, it is possible to correct actual value deviations due to unfavourable sensor location. The value measured by the controller is multiplied by the value set here.

H14, H24, H34, H44 Sensor selection F1..F4

With this parameter, you can define the sensor type. Depending on the hardware, not all sensor types may be supported. For the NTC sensor, a parallel resistor will have to be connected.

H15, H25, H35, H45 Software filter F1..F4

In this parameter, you can define how many measured values are to be used for calculating a mean value. A mean value is calculated from the last measured values, with the oldest measured value being deleted (so called "Moving Average Filter").

H16, H26, H36, H46 F1..F4: Display at 0 / 4mA

If, when choosing the sensor, H14 / H24 / H34 / H44 = 7 or 8 is selected (0...20mA

or 4..20mA linear sensor), you can define via this parameter which value is to be displayed in the case of a current of 0 or 4mA. The value to be displayed for 20mA can be defined in the next parameter. The actual measured value is calculated as linear interpolation between these two values.

H17, H27, H37, H47 F1..F4: Display at 20mA

If, when choosing the sensor, H14 / H24 / H34 / H44 = 7 or 8 is selected (0...20mA or 4..20mA linear sensor), you can define via this parameter which value is to be displayed in the case of a current of 20mA. The display value for 0 / 4mA is defined in the previous parameter. The actual measured value is calculated as linear interpolation between these two values.

H53 Weighting of sensor F1 for display H51 (weighted mean value of sensor F1 and F2)

This theoretical mean value from sensors F1 and F2 may be calculated for the control circuit or display. It is calculated as follows:

$$H51 = (H53 \times H11 + (100 - H53) \times H21) / 100$$

H99 Password for parameter level H--

Password for level H--.

┆-- Predefined parameter sets

(password protected)

┆┆ Internal: active data set

This parameter is to set certain predefined data sets. These are preset by Störk-Tronic. If a new data set is imported, all previously set parameters are overwritten. They can be changed freely afterwards. The data set can also be changed via the ST-Bus, provided that it has been enabled via **L42**.

┆2 Parameter Reset

With this parameter the parameters of the current parameter set (see **┆┆**) can be reset to their default settings.

To determine the value of the parameters to be reset, the values of the following bit mask must be added.

Bit	Value	Function
0	+1	Control parameters
1	+2	Clock (┆--)
2	+4	Relay counter (N98)
3	+8	Operating time (T98)
4	+16	Passwords

Depending on the set bit, the corresponding parameters are reset to factory settings, depending on the current parameter set (according to **┆┆**).

In order for this function to work, a release must be triggered with parameter **L42**=1.

Generally not volatile parameters such as T10 are not deleted!

┆98 Password for accessing level selection

With this parameter, you can set the level selection password, i.e. in display **PA**. In the standard design, access to level selection is blocked by password **-19**. This parameter cannot be set on the controller itself but only via the ST-bus.

┆99 Password of parameter level ┆--

The access to the parameter group **┆--** is blocked with the password **-19** in the standard version.

┆-- Networking and display

(password protected)

L0 ST-bus own address

With the address set here, the controller can be addressed via the bus. Each bus client must have its own address. Addresses must be unique, i.e. must not be assigned several times.

L2 Temperature scale

Here, you can define if temperature values are to be displayed in °F or °C.

L3 Display mode

Here, you can switch over between 3-digit and 4-digit display. However, if the hardware provides 3 digits only, the left digit will be lost, i.e. the sign in the case of negative numbers. You can also define here if values are to be displayed without decimal places, with rounded decimal place or exactly.

L4 Display value

Here, you can define which actual value is to be displayed. This refers to the display in normal operation. You will have to leave the parameter level in order to see the set value. Possible values which can be set via this parameter:

L4	Description
0	Last temperature before defrosting
1	Cold store temperature
2	Evaporator temperature
3	Cur. control value for evaporator fan
4	Current setpoint cold store, circuit 1
5	Condenser temperature (pressure?)
6	P-control result for condenser fan
7	Cur. control value for condenser fan
8	current setpoint of condenser
9	Cold store temperature via test bottle function
10	MIN value of cold store temperature since last reset
11	MAX value of cold store temperature since last reset
12	Act. value control circuit 2
13	Current setpoint control circuit 2

L6 Software version

Here, the software version of the controller is displayed.

L7 Display in standby mode

In this parameter, you can define what is to be displayed in standby.

L40 Mask on enabled funct. (Bit 0...7)

L41 Mask on enabled funct. (Bit 8...15)

Here, you can specify the functions enabled via the bus using a binary mask. The bits have the following meaning:

	Bit	Val.	Function
L40	0	+1	controller on/off
	1	+2	control circuit 1 on/off
	2	+4	control circuit 2 on/off
	3	+8	Control circuit 1: defrosting request
	4	+16	Control circuit 1: super-frost request
	5	+32	Control circuit 1: reserved
	6	+64	Control circuit 1: Set1/Set2 change-over
L41	7	+128	Control circuit 1: day/night change-over
	8	+1	Control circuit 2: defrosting request
	9	+2	Function A: light 1
	10	+4	Function B: light 2
	11	+8	Function C: window heating
	12	+16	Function D: door frame heating
	13	+32	Function E: blade scraper
	14	+64	Function F: reserved
	15	+128	reserved

To determine the value to be parameterised, all valences must be added together.

L42 Release to delete counters/ Run times

Here the deletion of the running times, the relay counters and the min/max memory is enabled for 10 min. Only within the 10 min. the parameters T98, N98 and A17 can actively delete the corresponding timers, counters or memory locations. After the 10 min. have elapsed, the release is removed. The deletion of the min/max memory by a function assignment of the keys is not influenced by this.

L99 Password for parameter level ┆--

With this parameter, you can set the password for parameter level **┆--**.

U-- Relay contacts and lamps

(password protected)

U1 ... U8 Function relay K1...K8

Assignment of internal output signals to the corresponding output relays.

U11 ... U16 Function LED 1...6

Assignment of status LEDs (signal lamps) to the internal signals.

U20 Function LED weekdays

If 1 is entered here, the 7 LEDs are assigned to the weekdays. In this case, parameters **U21...U27** will not be active. If 2 is entered, the LEDs will be assigned according to parameters **U21...U27**.

U21 ... U27 Function LED 7..13 (Mo..Su)

Assignment of weekday LEDs to certain internal signals (signal lamps).

U99 Password of parameter level U--

With this parameter, you can set the password for parameter level **U--**.

Y-- Control circuit 2

(password protected)

Y0 Assignment of sensor for independent 2nd control circuit (thermostat)

With this parameter, you can set which sensor input is to be assigned to the 2nd control circuit.

Y1 Control circuit 2: setpoint

Here, you can set the setpoint for the 2nd control circuit (thermostat). If a button is parameterised accordingly, the setpoint can also be viewed and set up via this button directly.

Y2 Control circuit 2: absolute/relative setpoint

If **Y2=0**, the setpoint **Y1** is an absolute value, if **Y2=1** the setpoint of control circuit 2 is the sum of **Y1** and the actual setpoint **c1/c2/c3**.

Y4 Control circuit 2: switching mode

Heating contact or cooling contact.

Y5 Control circuit 2: hysteresis

In this parameter, you can specify the control hysteresis. A small hysteresis enables exact control, but will result in frequent switching of the relay.

Y6 Control circuit 2: Hysteresis mode

With this parameter you can define if the hysteresis will be active at the corresponding switching point symmetrically or on one side only. In the case of a one-sided hysteresis, the hysteresis will be active below the setpoint in the case of the heating function [**Y4=0**] and above the setpoint in the case of the refrigerating function [**Y4=1**]. In the

case of a symmetrical hysteresis, there is no difference.

Y7 Control circuit 2: upper setpoint lim.

Y8 Control circuit 2: lower setpoint limit

With these parameters, you can limit the setting range of setpoint **Y1** to avoid that the end user does not enter non-permissible values.

Y9 Control circuit 2: Function in the case of sensor fault

Here it is defined whether the controlled output contact opens or closes in case of an error of the assigned sensor.

Y10 Control circuit 2: Defrost interval

The defrosting interval defines the time after which a defrosting operation is started. As soon as the defrosting cycle is triggered, the defrosting interval starts again. In this way, periodic defrosting at a fixed time interval is ensured.

Y11 Control circuit 2: Defrosting time limitation

Here, you can set the max. time in which the defrosting operation must be completed.

Y99 Password of parameter level Y--

With this parameter, you can set the password for parameter level **Y--**.

Measuring inputs	<p>F1: Temperature sensor PTC or Pt100, refrigerating chamber</p> <p>F2: Temperature sensor PTC or Pt100, evaporator</p> <p>Measuring range: PTC (KTY81-121) -50°C...+130°C</p> <p>Accuracy: $\pm 0.5K \pm 0.5 \%$ at 25°C $\pm 1K \pm 0.5 \%$ of scale range (0...+55°C), without sensor</p>
Outputs	<p>K1: Relay, normally-open contact, 20(4)A 250V\sim permanent current max. 16(4)A, limited by connectors and/or conductive strips</p> <p>K2: Relay, normally-open contact, 16(2,2)A 250V\sim</p> <p>K3: Relay, normally-open contact, 5(1)A 250V\sim</p> <p>Please note: K1, K2 and K3 have a common and potential-afflicted connection. The total current at terminal X2, Pin 2 may not exceed 16A!</p>
Display	<p>1 3-digit LED display, height 13mm, colour red, temperature display.</p> <p>3 LEDs, diameter 3mm, colour red, for status display</p>
Interface	<p>ST-Bus communication interface</p> <p>Interface driver: RS485, galvanically not separated</p> <p>The network has to be installed in lines topology and terminated with a 120 Ohm resistance on each side.</p> <p>In case of networking always connect port "A" with port "A" and port "B" with port "B".</p> <p>Crossing over is not permissible!</p>
Power supply	230V \sim 50/60 Hz, power consumption max. 5 VA
Connectors	<p>Terminals</p> <p>X1: Screw terminal, 5 pole, spacing 5.0 mm, for cable up to 2.5 mm²</p> <p>X2: Screw/plug-in terminal, 5 pole, spacing 3.5 mm, for cable up to 1.5 mm²</p>
Ambient conditions	<p>Storage temperature: -20...+70°C</p> <p>Operating temperature: 0...+55°C</p> <p>Relative humidity: max. 75% without dew</p>
Weight	ca 300 g, without sensor
Enclosure	Front IP65, IP00 from back
Installation data	<p>Unit is to be installed in an instrument panel.</p> <p>Front size: 120 x 42 mm</p> <p>Panel cut-out: 102.5 x 35 mm</p>

