

Temperature controller

Order number: 900320.001

As of: 08.09.2020 V1.20



Wiring diagram

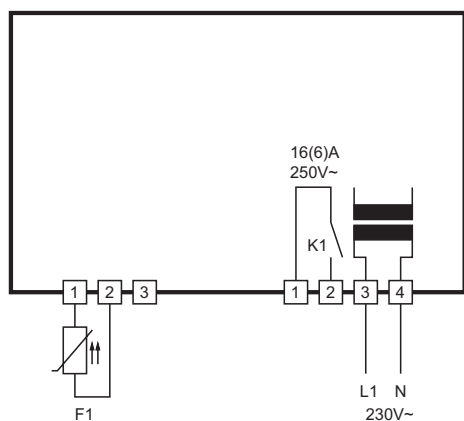

Product description

The controller ST121-JA1TA.10 was specifically developed for direct switching at high performances. Given the high maximum electric load of 16A (ohm) and 6A (inductive) it can operate without cut-out relay in many cases. The controller is supplied with 230V AC and has 4 keys. Three of them serve for controller adjustments, the fourth key activates the standby function.

Sensor: multi-resistance input

Range: dependent on type of sensor

Front size: 120mm x 42mm

Panel cut-out: 102,5mm x 35mm

Tightness: front IP65

Connector: screw terminal

Control keys



Key 1: UP

Pressing this key increases the parameter or parameter value.



Key 2: DOWN

Press this key to reduce the parameter or parameter value.

In case of alarm, the buzzer function is switched off by pressing the key.



Key 3: SET

While this key is pressed, the setpoint is displayed. This key is also used for parameter setting.



Key 6: Standby

Press this button to switch the controller to standby mode. It can be switched on again by pressing it again.

Operating levels:

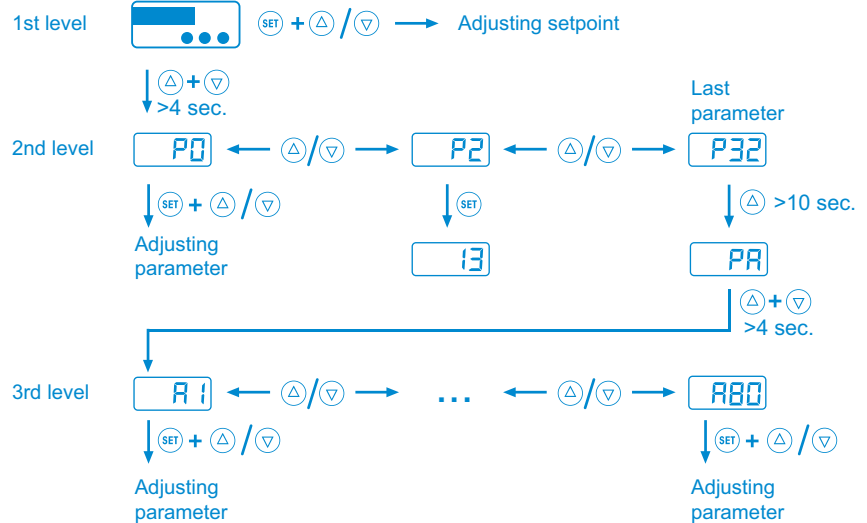

1st control level:

Adjusting the setpoints

The setpoint S1 can be selected directly by pressing the SET key. It can be adjusted by additionally pressing the UP or DOWN key. By corresponding parameter settings (see **A85**, **A86**) a setpoint changeover can be carried out with a selector key (if available). The modified setpoint S1' is then controlled and accordingly the setpoint S1' is displayed by pressing the SET key.

S1' can be defined as a difference to setpoint S1, or as an absolute setpoint (see parameter **A33**).

2nd control level (P parameters):

Adjusting control parameters

By pressing the UP and DOWN keys simultaneously for at least 4 seconds, you can access a parameter list for control parameters (starting at **P0**).

Use the UP key to scroll up the list and the DOWN key to scroll down again.

Pressing the SET key displays the value of the respective parameter. By additionally pressing the UP or DOWN key the value can be adjusted.

After releasing all keys, the new value is stored permanently. If no key is pressed for more than 60 seconds, the system automatically returns to the basic status.

3rd control level (A parameters):

Adjusting control parameters

The third operating level can be reached by first going to the second level and scrolling through the parameter list to the highest parameter. Afterwards only the UP key is pressed for at least 10 seconds. The message **PR** appears in the display.

Then press the UP and DOWN keys simultaneously for at least 4 seconds to access the parameter list of the third operating level (starting at **A1**).

Use the UP key to scroll up the list and the DOWN key to scroll down again. If the SET key is pressed, the value of the respective parameter is displayed and the value can be adjusted by additionally pressing the UP or DOWN key.

After releasing all keys, the new value is stored permanently. If no key is pressed for more than 60 seconds, the system automatically returns to the basic status.

1st operating level (Setpoint)

Parameter	Functional description	Adjustment range	Standard value	Custom value
S1	Setpoint control contact 1	P4...P5	0.0 °C	
S1'	Difference to setpoint S1 Absolute setpoint S1'	-99...+99.9 K if R33=1 P4...P5, if R33=2	0.0 °C/K	

2nd control level (P parameters):

Parameter	Functional description	Adjustment range	Standard value	Custom value
P0	Display actual value	-	-	
P2	Hysteresis control contact 1	0.1...99.0 K	1.0 K	
P4	Lower setpoint limit	-99 °C...P5	-99 °C	
P5	Upper setpoint limit	P4...999 °C	999 °C	
P6	Actual value correction	-10.0...+10.0 K	0.0 K	
P19	Key lock	0: not locked 1: locked	0	
P30	Lower alarm limit value	-99...999 °C/K	-99 °C	
P31	Upper alarm limit value	-99...999 °C/K	100 °C	
P32	Hysteresis alarm, one-sided	0.1...99.9 K	1.0 K	
d0	Defrosting interval	0...99 h 0 = no defrosting	0	
d2	Defrost temperature limit	-99.0...999.9 °C	10.0 °C	
d3	Defrost time limit	0...99 min. 0 = without time limit	30 min	

3rd control level (A parameters):

Parameter	Functional description	Adjustment range	Standard value	Custom value
R1	Switching mode control contact	0: heating contact 1: cooling contact 2: alarm function	0	
R3	Function at sensor error (if heating or cooling contact)	0: relay off 1: relay on	0	
R8	Actual value - display mode (all parameter values are displayed with 0.1 °C)	0: integer 1: Resolution 0.5 °C 2: Resolution 0.1 °C	1	
R9	Weighting factor	0.50 ... 1.00	1.00	
R19	Parameter lock	0: no locking 1: A parameters locked 2: A and P parameters locked	0	
R30	Function Alarm contact	0: Boundary value alarm, relative 1: Boundary value alarm, absolute 2: Range alarm, relative 3: Range alarm, absolute 4: Boundary value alarm, relative, alarm contact inverse 5: Boundary value alarm, absolute, alarm contact inverse 6: Range alarm, relative, alarm contact inverse 7: Range alarm, absolute Alarm contact inverse	0	

Parameter	Functional description	Adjustment range	Standard value	Custom value
R31	Special function on alarm	0: not active 1: Display flashes 2: Buzzer active 3: Display flashes, buzzer active 4: same as 3, buzzer can be acknowledged 5: same as 4, again after 10 minutes 6: same as 4, again after 30 min	0	
R32	Display mode	0: actual value display 1: Setpoint display	0	
R33	Type of setpoint S1'(Setpoint reduction)	0: cannot be activated 1: relative to setpoint S1 2: absolute (freely adjustable)	0	
R40	Hysteresis mode for heating / cooling function	0: symmetrical 1: one-sided	1	
R50	Minimum action time control contact "On"	0...400 s	0 s	
R51	Minimum action time control contact "Off"	0...400 s	0 s	
R54	Delay after "Power ON"	0...400 s	0 s	
R56	Alarm suppression after "Power ON" or setpoint switching	0...60 min	0 min	
R60	Sensor type	11: Pt100 2-wire 21: PTC 22: PT1000 2-wire	11	
R70	Software filter	1: not active 2...32: average value over 2...32 measured values (approx. 0.6...9.6 sec.)	4	
R80	Temperature scale and display in standby mode	0: Fahrenheit (AUS) 1: Celsius (AUS) 2: Fahrenheit (OFF) 3: Celsius (OFF)	1	
R85	Function of selector key A (if available)	0: no function 1: Display actual value (with R32 =1) 2: Activate setpoint S1' (for R33 >0)	0	
R86	Function of selector key B (if available)	0: no function 1: Display actual value (with R32 =1) 2: Activate setpoint S1' (for R33 >0)	0	
R87	Function standby key	0: no function 1: controller on/off (standby), after power on as before 2: like 1, after power-on always off 3: like 1, after power-on always on	1	
R88	Delay at Standby-On	0.1...3.0 sec.	0.1 sec.	
R89	Delay at Standby-Off	0.1...3.0 sec.	0.1 sec.	
Pro	Program version	-	-	

**2nd operating level,
(P parameters):**

P2: Hysteresis control contact 1

The hysteresis can be set symmetrically or on one side at the setpoint (see [R40](#), [R41](#)). In the case of one-sided setting, the hysteresis is effective downwards for the heating contact and upwards for the cooling contact. In the case of symmetrical hysteresis, half the value of the hysteresis is effective above and below the switching point.

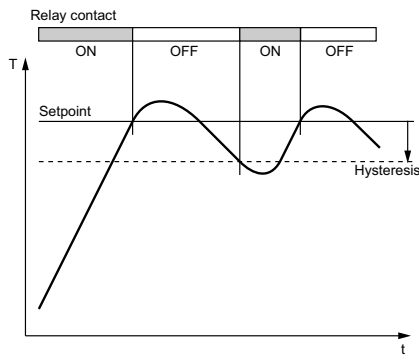

Heating controller, one-sided hysteresis

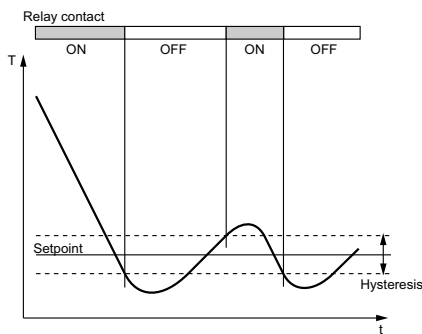

Cooling controller, symmetrical hysteresis

P4: Lower setpoint limitation

P5: Upper setpoint limit

The adjustment range of the setpoint can be limited upwards and downwards. This prevents the end user of a system from setting impermissible or dangerous setpoints.

P6: Actual value correction

The value set here is added to the measured sensor value. The modified measured value is displayed and serves as the basis for the control.

P19: Key lock

The key lock allows the operating keys to be locked. When locked, the setpoint cannot be changed using the keys. If an attempt is made to adjust the setpoint despite the keys being locked, the message "----" is displayed.

P30: Lower alarm limit value

P31: Upper alarm limit value

The Alarm output is a boundary or range alarm with one-sided hysteresis (see parameter [P32](#)).

The limit values can be relative for both boundary and range alarm, i.e. they can run with set-

point S1/S1', or absolute, i.e. independent of Setpoint S1/S1'.

The hysteresis acts unilaterally inwards for boundary alarms and outwards for range alarms.

P32: Hysteresis alarm, one-sided

The hysteresis is set to the set limit value on one side. It is effective depending on the alarm definition (see pictures).

d0: Defrost interval

The "Defrost interval" determines the time after which a defrosting operation is initiated. After each defrost start this time is reloaded and processed.

If no defrost is desired, defrost can be disabled by setting $d0=0$. Then only manual defrost initiated by the UP key is possible.

d2: Defrost temperature

A defrosting operation is ended when the temperature set in $d2$ is exceeded at the cold room sensor.

As the appliance does not have an active defrosting device, defrosting is also ended by exceeding a time limit (see parameter [d3](#)).

d3: Defrost time limit

A defrosting operation cannot take longer than the time set here. If the time is exceeded, the defrost will be stopped. With setting $d3=0$ the time supervision is inactive.

**3rd operating level,
(A parameters):**

The following values can change the device properties and must therefore be carried out with the greatest care:

R1: Switching direction control contact

The switching direction for the controller is adjustable as heating, cooling or alarm function. With the heating controller the respective contact is closed if the actual temperature is lower than the setpoint temperature. With the cooling controller it is the other way round. Configured as an alarm function, the behavior is the same as set in parameter [R30](#).

R3: Function of control contact in case of sensor error

In case of sensor error, the control contact takes on the state set here. If an error is detected in the parameter memory (display [EP](#)) and therefore the stored settings cannot be used, all relays are set to the de-energized state.

R8: Display mode

The actual value can be output as an integer or with one decimal place in the resolution 0.5°C or 0.1°C. When displayed with a resolution of 0.5°C, the actual value is rounded up or down. In principle, all parameter settings and setpoints are displayed with a resolution of 0.1°C.

R9 Weighting factor

The actual value can be weighted with this parameter. The measured value is multiplied by it and shown in the display as well as used for the control.

R19: Parameter lock

This parameter allows the individual parameter levels to be locked step by step. When the A level is locked, only parameter [R19](#) itself can be changed.

In the locked state, the parameters are displayed, but they cannot be changed using the keys. If an attempt is made to change the parameters despite the keys being locked, the message "----" appears in the display.

R30: Function alarm contact

The Alarm output evaluates an upper and a lower limit value (see parameters [P30](#) and [P31](#)). Here you can select whether the alarm is active when the temperature is within these two limits or whether an alarm is given when the temperature is outside. In case of sensor error, the alarm is activated regardless of this setting.

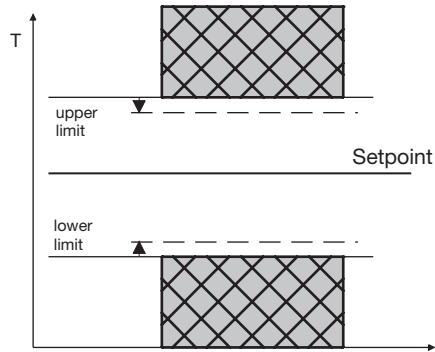

Boundary alarm, alarm contact normal
A30=0 relative, A30=1 absolute

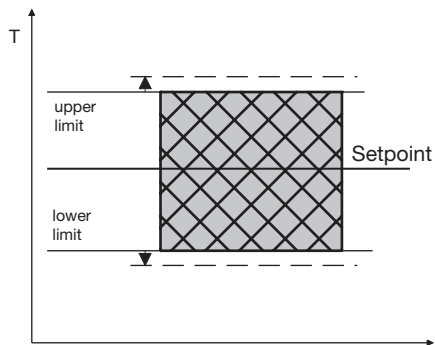

Range alarm, alarm contact normal
A30=2 relative, A30=3 absolute limits

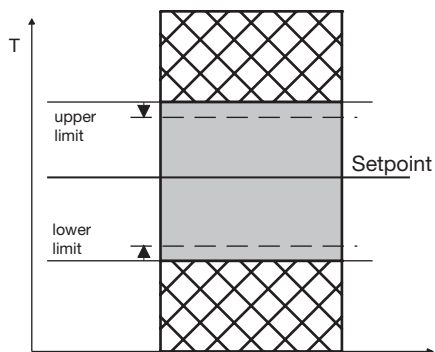

Boundary alarm, alarm contact inverse
A30=4 limits relative, A30=5 absolute

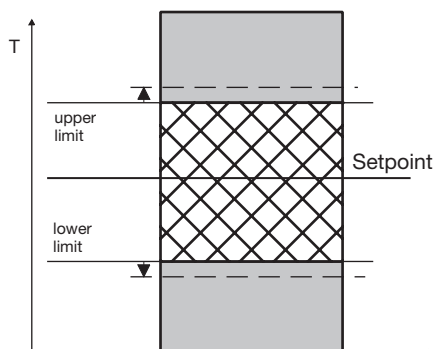

Range alarm, alarm contact inverse
A30=6 limits relative, A30=7 absolute

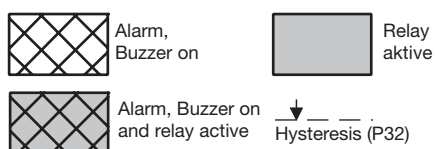

R31: Special function on alarm

Here you can select whether the buzzer should sound in case of an alarm and whether the display should flash. The alarm can be acknowledged with the DOWN key, so the buzzer can be switched off despite the alarm function being active.

R32: Type of display

With R32=0 the actual value is displayed, while with R32=1 the setpoint S1 or S1' is permanently displayed.

R33: Type of setpoint S1'

The modified setpoint S1' is either defined as the difference to the setpoint S1 (relative to S1) and adjusted with the same distance when S1 is changed, or it is defined as an absolute value independent of S1.

R40: Hysteresis mode control contact

With this parameter it can be selected whether the hysteresis at the respective switching point is symmetrical or one-sided. A one-sided programmed hysteresis is set below the setpoint for the heating function and above the setpoint for the cooling function; there is no difference for symmetrical hysteresis.

R50: Minimum action time contact 'On'

R51: Minimum action time contact 'Off'

These parameters allow to delay the switching on or off of the respective output contact to reduce the switching frequency. The set time defines the total minimum duration of a switch-on or switch-off phase. This time is also effective when configured as alarm contact.

R54: Contact delay after "Power ON"

This parameter enables a delayed switch-on of the control contact after the supply voltage is switched on. Thus, an overload of the power supply system by simultaneously switching on many consumers can be avoided.

R56: Alarm suppression time after "ON" or setpoint switching

After switching on the control system, a certain amount of time elapses until the working temperature is reached, especially in cooling systems. This would result in an unwanted alarm message.

For this reason, parameter R56 can be used to set an expiration time during which no alarm is reported.

This suppression time is also effective after a setpoint change (S1 <-> S1').

R60: Sensor selection

Depending on the hardware used, not all sensor types can be selected.

R70: Software filter

The average value is calculated over the number of measurements set here.

R80: Temperature scale

The display can be switched between Fahrenheit and Celsius. By changing over, the parameters and setpoints retain their numerical value and setting range. (Example: A controller with a setpoint of 0°C is changed to Fahrenheit. The new setpoint is then interpreted as 0°F, which corresponds to a temperature of -18°C).

R85: Function selector key A (if available)

R86: Function selector key B (if available)

0: key is without function

1: Display actual value if R32=1 (display setpoint), otherwise no function

2: Switching from setpoint S1 to a modified setpoint S1' if R33=1 or R33=2

R87: Function of standby key

In this parameter the function of the standby key (if available) is set.

R88: Delay before standby on

R89: Delay before standby off

For the standby button a delay can be provided separately for both switching directions.

Message	Cause	Measures
RU5 or OFF	Standby mode, no control	Switch on by key or switching input
F IL	Sensor error, short circuit	Check sensor or sensor terminal
F IH	Sensor error, sensor break	Check sensor or sensor terminal
---	Key lock active	see parameter P 19 or A 19
Flashing display	Temperature alarm (see R3 I)	
Buzzer	Temperature alarm (see R3 I) or sensor error	The buzzer can be acknowledged with the DOWN key.
EP	Data loss in the parameter memory (control contact 1 and 2 are current-free)	If the error cannot be eliminated by switching the power off and on, the controller must be repaired

Sensor error messages are stored and displayed even after the cause of the error has been eliminated. The error message can be deleted by acknowledging it with the DOWN key.

Technical data

Measuring input	F1: Resistance sensor PTC, Pt100 or Pt1000, 2-wire connection Measuring range: Pt100 -80°C...+400 °C Pt1000 -99°C...+350°C PTC -50°C...+150 °C Measuring accuracy of the controller at 25°C: +/-0.5K and +/-0.5% of measuring range
Outputs	K1: Relay, normally-open contact, 30(6)A 250V~, permanent current max. 16(6)A, limited by connectors and/or conductive strips Additional buzzer, 85dB
Display	One 3-digit LED-Display, height 13 mm, colour red 1 LED diameter 3mm, colour red, for status display of output K1
Power supply	230V~ 50/60 Hz, power consumption max. 5 VA
Connectors	Screw terminals X1: 3-pole, spacing 5.0 mm, for cable up to 2.5 mm ² X2: 4-pole, spacing 5.0 mm, for cable up to 2.5 mm ²
Ambient conditions	Storage temperature: -20 °C ... +70 °C Working temperature: 0 ... 55 °C Relative humidity: max. 75 %, no condensation
Weight	ca 300 g, without sensor
Enclosure	Front IP65, IP00 from back
Installation data	Front size: 120 x 42 mm Panel cutout: 102.5 x 35 mm Installation depth max. 47mm

